

A-34/54

SERVICE MANUAL

[A-34]

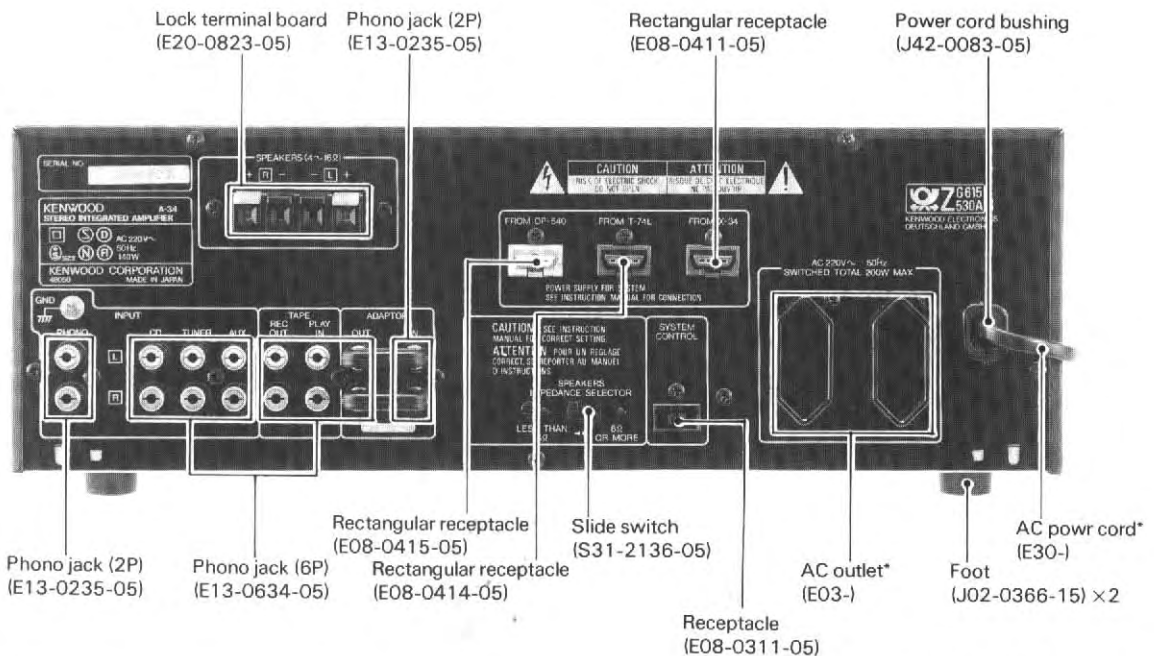
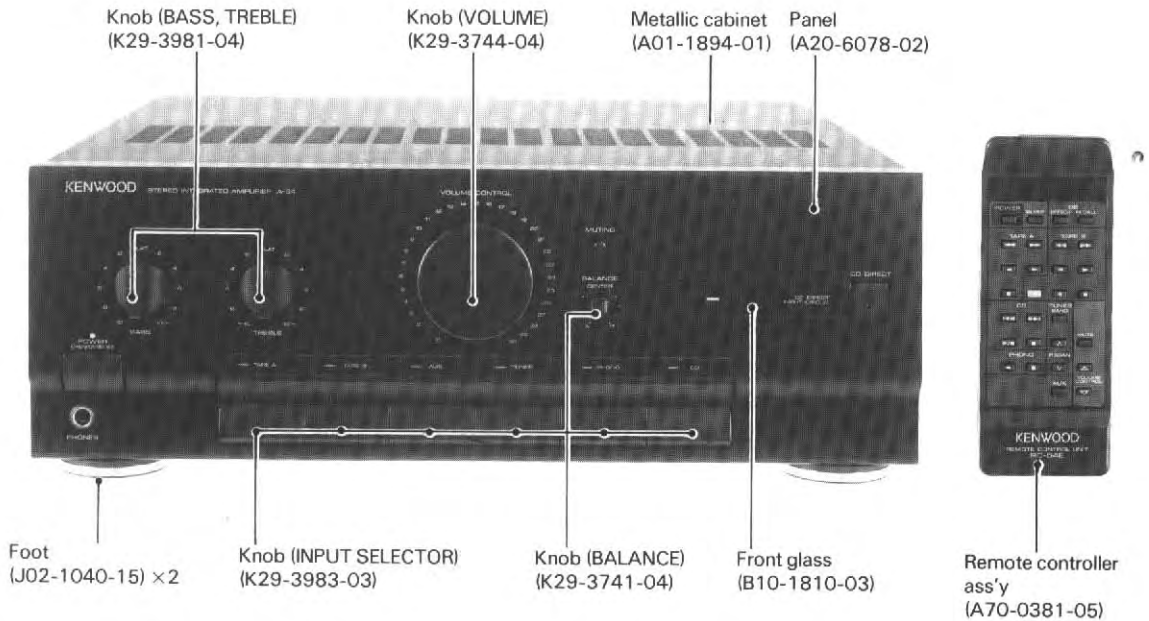

*Refer to parts list on page 14.

A-34/54

[A-54]

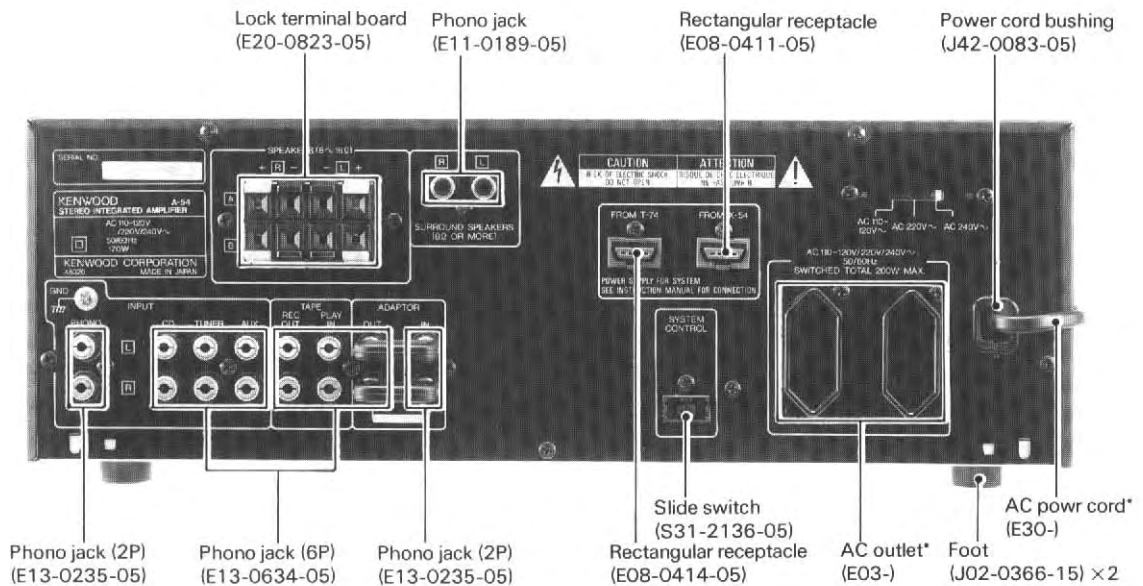
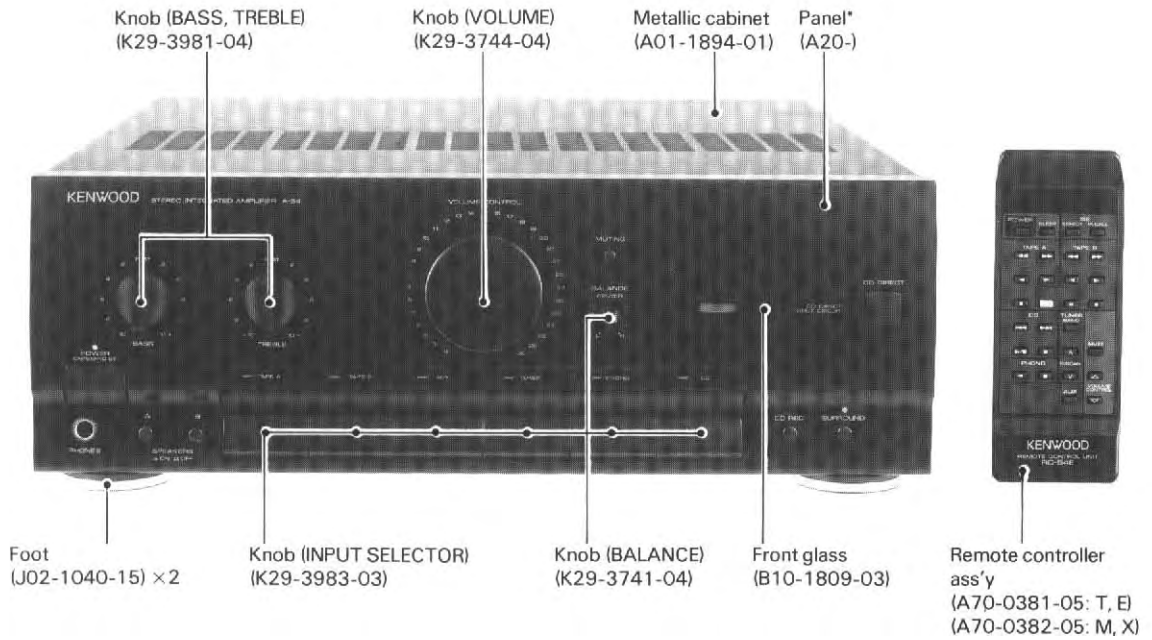

*Refer to parts list on page 14.

WIRING DIAGRAM

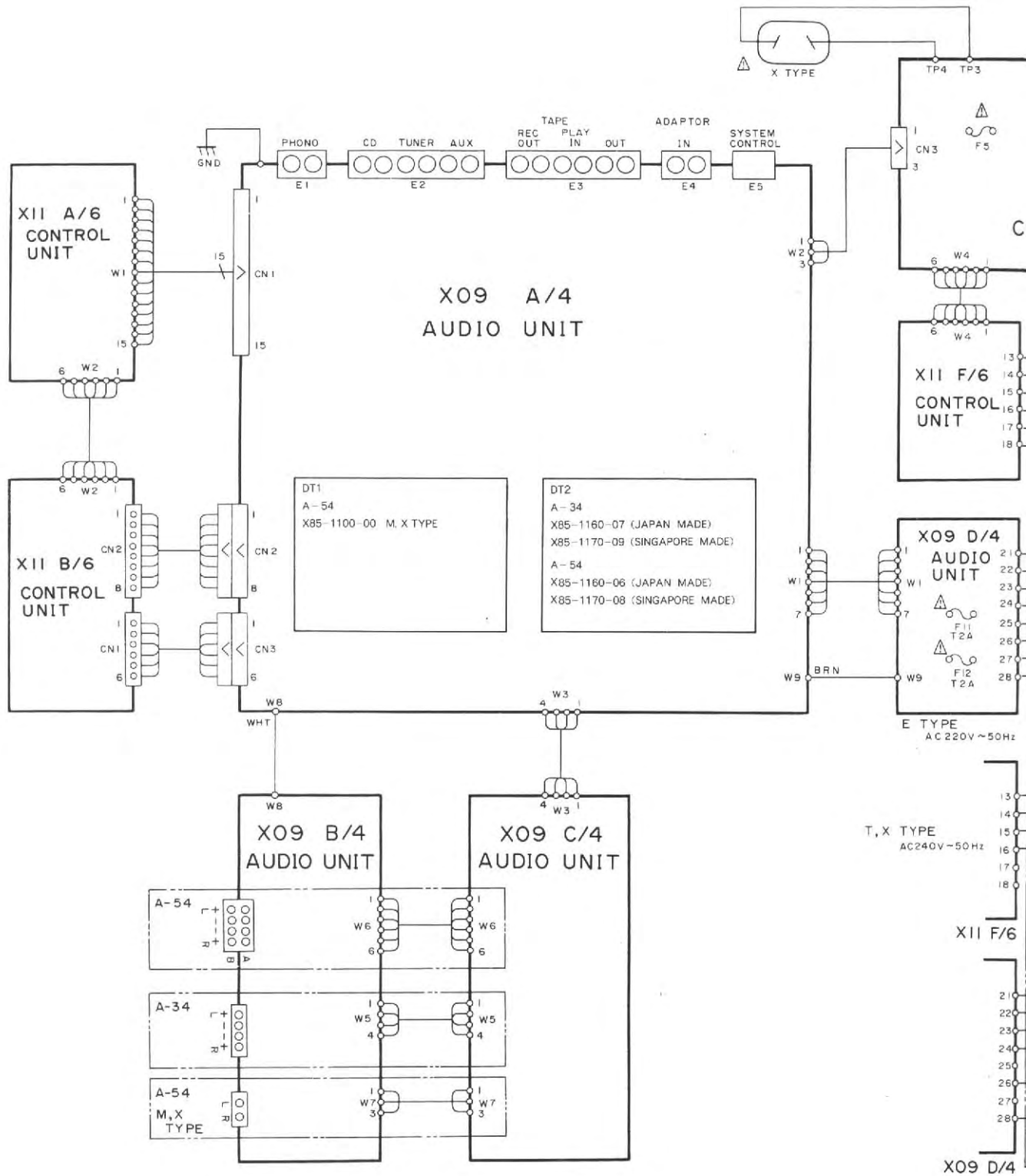

A34 / 54

A-34/54

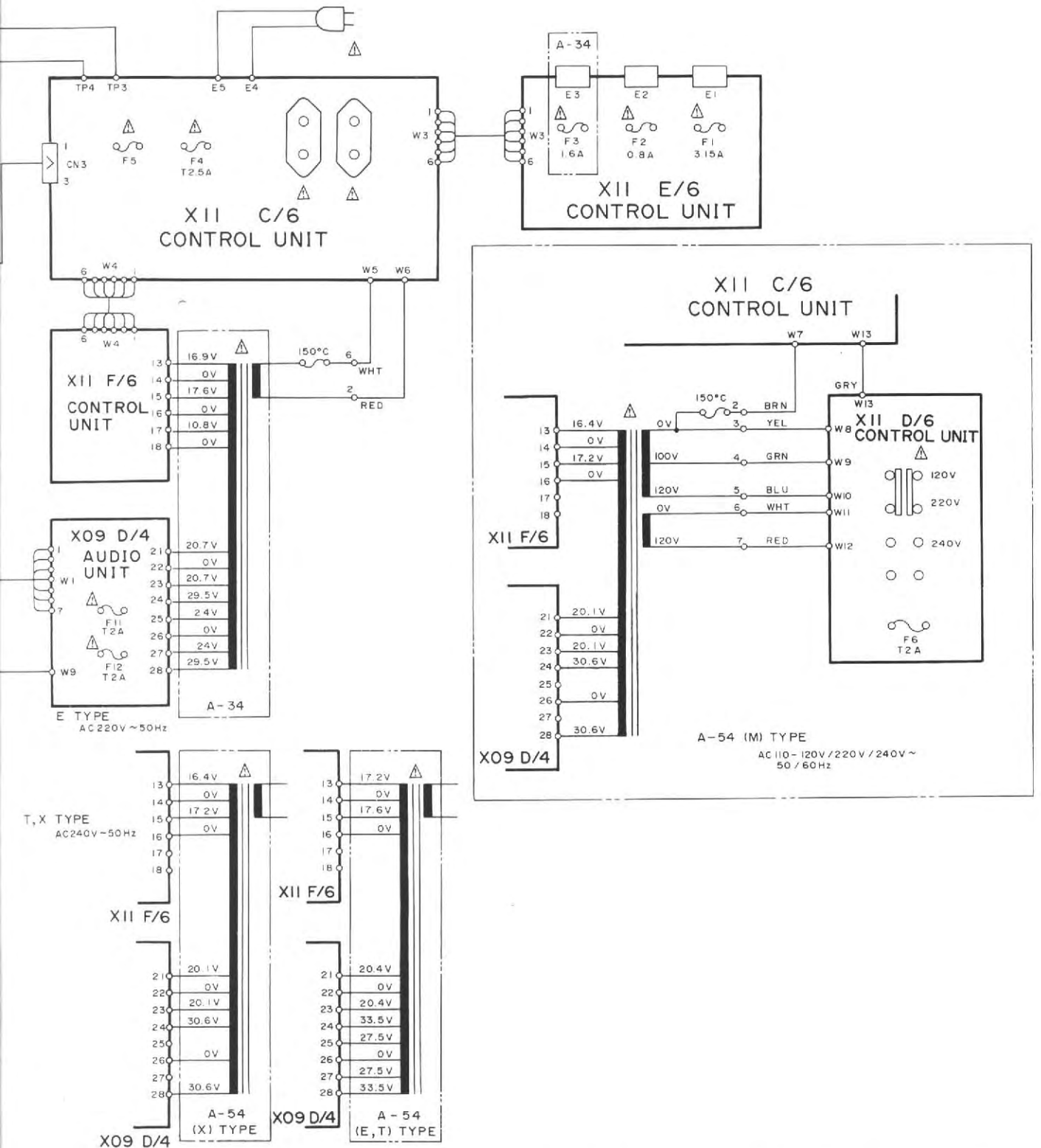

DESTINATION	AUDIO UNIT	CONTROL UNIT	POWER TRANSFORMER	DT-1	DT-2	FUSE F5	
A-34	X X09-3190-71	X11-2930-72	L07-0142-05	NO	X85-1160-07	T1.25A	
	T X09-3192-71	X11-2930-53					
	E X09-3192-71	X11-2932-72					
A-54	X X09-3190-21	X11-2930-71	L07-0211-05	X85-1100-00	X85-1160-06	T2A	
	M X09-3190-21	X11-2930-21	L07-0140-05			T2A	
	T X09-3192-70	X11-2930-52	L07-0139-05			NO	T1.6A
	E X09-3192-70	X11-2932-71	L07-0138-05				

AUDIO UNIT

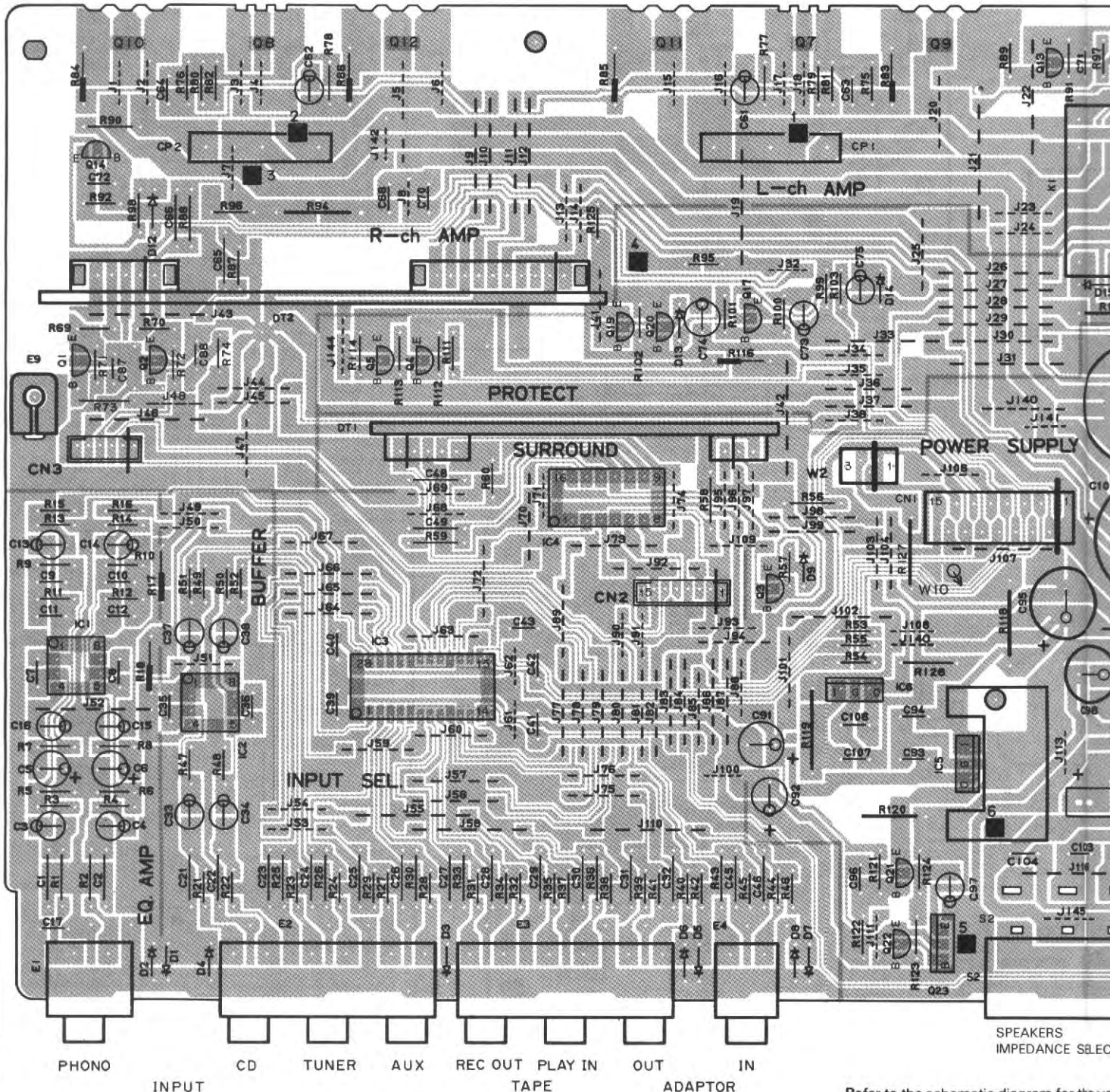
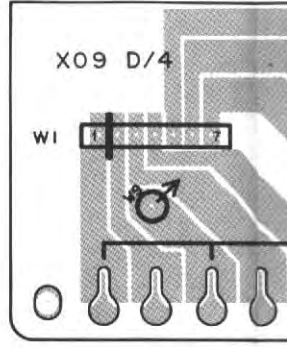

Refer to the schematic diagram for the va

MAIN AMPLIFIER UNIT

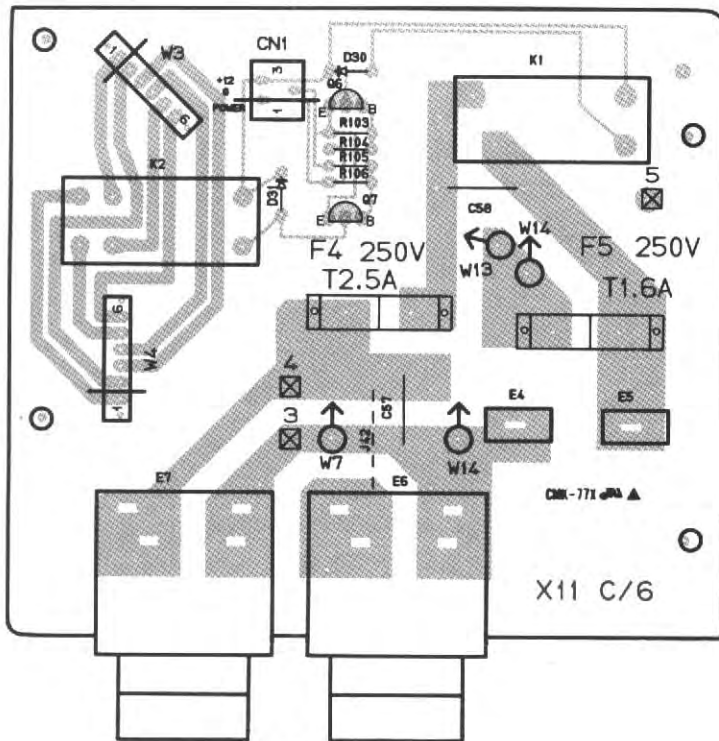

AC 110 - 120 V / 220V / 240V ~
50/60Hz
SWITCHED TOTAL 200W MAX

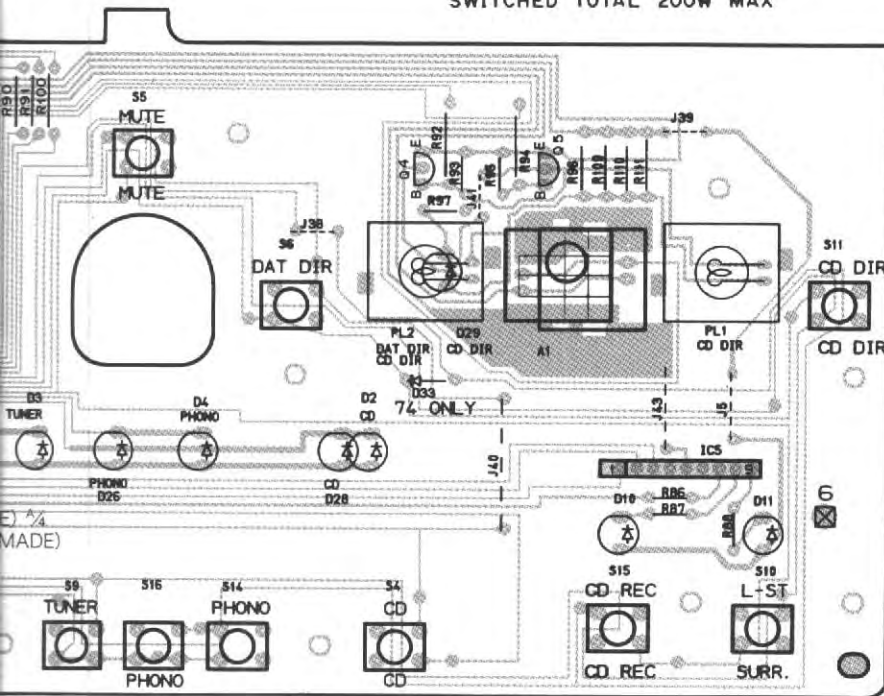
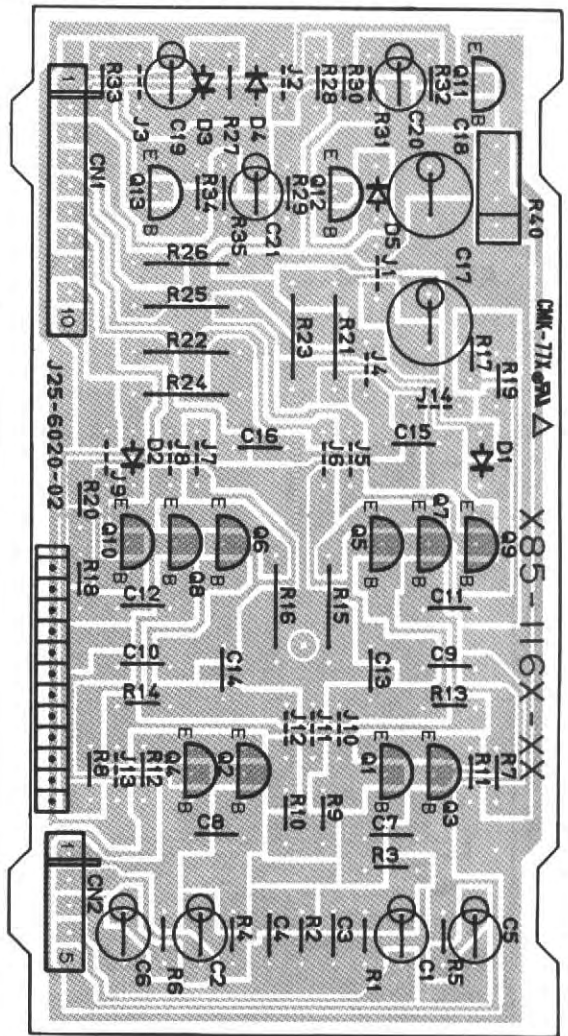

Refer to the schematic diagram for the values of resistors and capacitors.

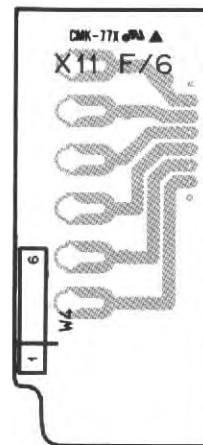

X85-11XX-XX

Ref. No.	IC	Q	Address
1		1	2S
2		2	2T
3		3	2S
4		4	2T
5		5	3S
6		6	3T
7		7	3S
8		8	3T
9		9	3S
10		10	3T

X11-293X-XX

Ref. No.	IC	Q	Address	Ref. No.	IC	Q	Address
1		1	3K	1		1	5M
2		2	3K	2		2	5N
3		3	6L	3		3	3N
4		4	5P	4		4	3L
5		5	5Q	5		5	6Q
6		6	2Q				
7		7	2Q				
8		8	5N				

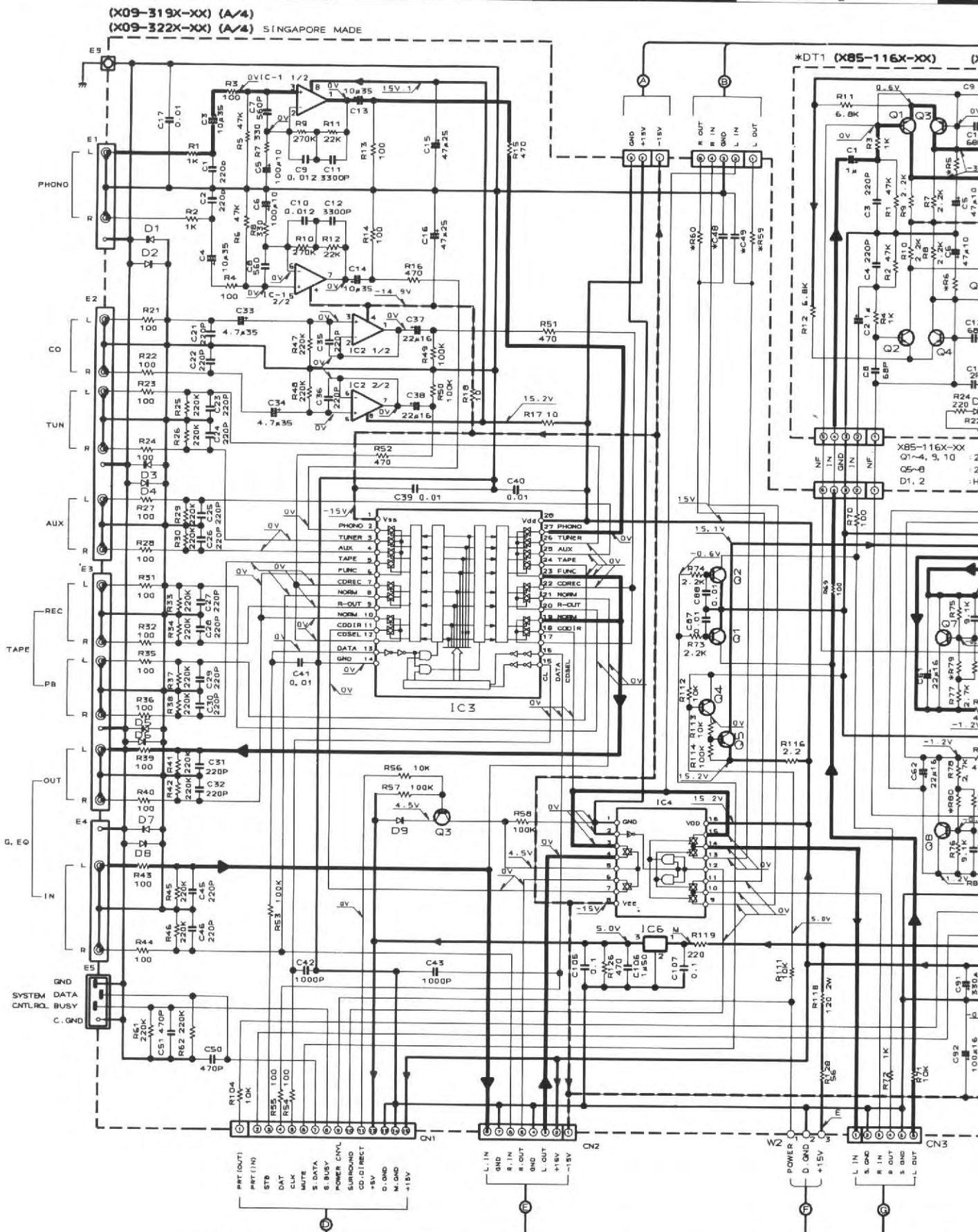

X09-319X-XX

		DT1	C48 C49	C67 C68	C69 C70	C79 C80	C81 C82	C83 C84	C101, 102	R59 R60	R79 R80	R91 R92	Q9 Q10	Q11 Q12	D16	S1A, B	S2	W5	W6	W7	W8	
A-34	X	0-71	NO	NO	0.047	NO	NO	NO	YES	4700 μ 50	NO	560	3.6K	25B1476	25D2231	RBV-402LFA	NO	YES	YES	NO	NO	NO
	E, T	2-71	NO	NO	0.1	0.1	YES	YES	YES	4700 μ 50	NO	560	3.6K	25B1476	25D2231	RBV-402LFA	NO	YES	YES	NO	NO	YES
A-54	M, X	0-21	YES	YES	0.047	NO	NO	NO	NO	4700 μ 56	YES	470	3.3K	25B1492	25D2254	RBV-602LFA	YES	NO	NO	YES	YES	NO
	E, T	2-70	NO	NO	0.1	0.1	YES	YES	YES	4700 μ 56	NO	470	3.3K	25B1502	25D2275	RBV-602LFA	YES	YES	NO	YES	NO	YES

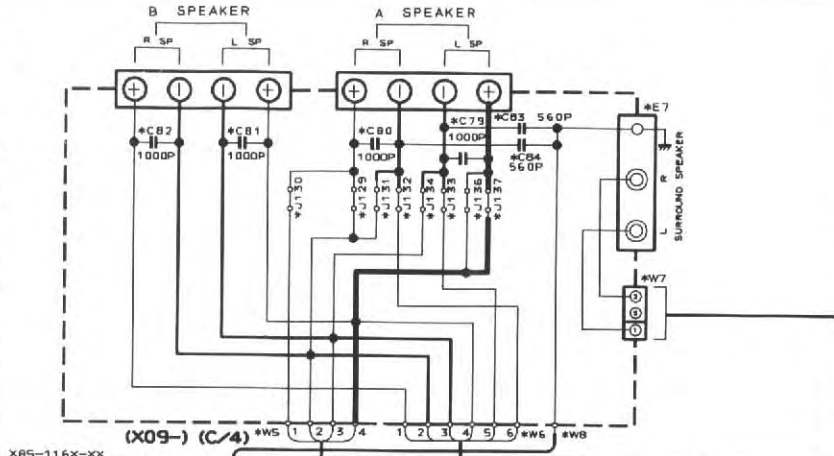
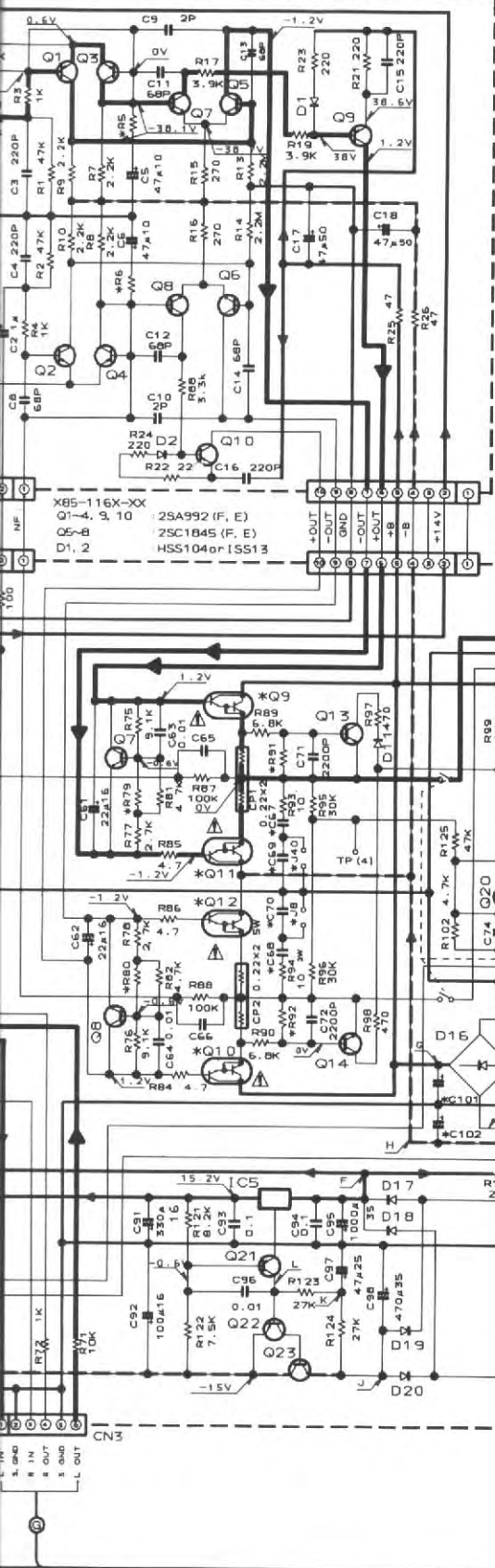

X85-116X-XX

A-34	0-07	E, T, X	750	75
A-54	0-06	E, T	520	60
A-54	0-07	M, X	750	75

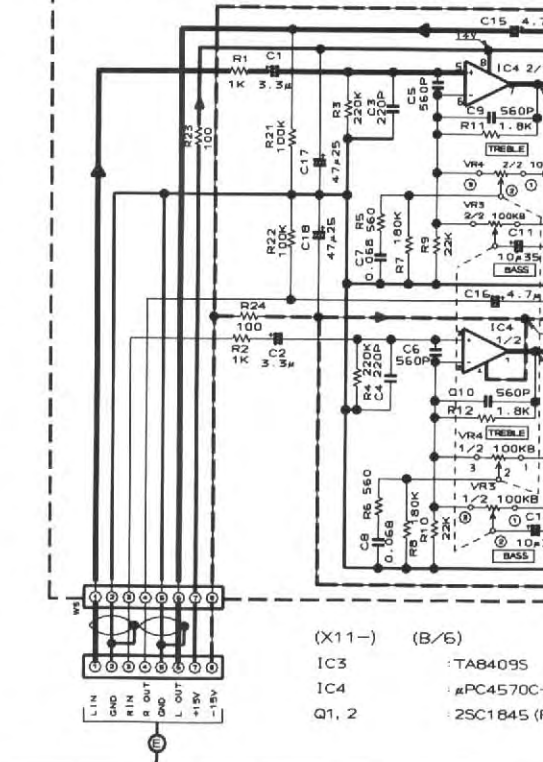
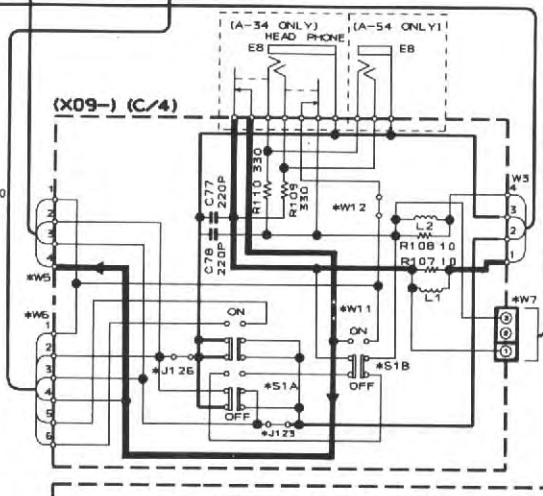

- X09-318X-XX
- IC1 : μM5800-D
- IC2 : or μPC4570C-A
- IC3 : μM565D
- IC3 : TC9164N
- IC4 : TC9215P
- IC5 : μPC7815HF
- IC6 : or AN7815F
- IC6 : LM2940CT-5
- Q1, 2 : 2SC2878 (B)
- Q3, 5, 21, 22 : 2SA733 (A) (QP)
- Q3, 5, 21, 22 : 2SA933S (QR)
- Q4, 19, 20 : 2SC945 (A) (QP)
- Q4, 19, 20 : 2SC1740S (QP)
- Q7, 8 : 2SC4131
- Q9, 10 : 2SD2231 (A34)
- Q9, 10 : 2SD2254 (A54)
- Q9, 10 : or 2SD2275 (A5)
- Q11, 12 : 2SB1476 (A34)
- Q11, 12 : 2SB1502 (A54)
- Q13, 14 : 2SC1845 (FE)
- Q17 : 2SA992 (F, E)
- Q18 : 2SC2003 (L, K)
- Q23 : 2SD1266 (QP)
- D1-9 : ISS104
- D1-9 : or HSS133
- D11-13, 15 : ISS104A
- D11-13, 15 : or HSS131
- D14 : or HZS4, 7ES (B)
- D14 : D35BA20F03 (A)
- D16 : or RBV-402LFA (A-34)
- D16 : D55BA20F03 (A)
- D16 : or RBV-602LFA (A-54)
- D17-20 : S5566B
- X11-293X-XX
- IC1 : μPD75004CU-067
- IC2 : P5T524D
- IC5 : TD62554S
- Q3 : 2SA733 (A) (Q)
- Q4, 5 : or 2SA933 (Q, R)
- Q4, 5 : 2SC2320 (F, E)
- Q8 : DTA124ES
- D1-11, 23-29, 830-1291-05 : or HSS104A
- D12-21, 32 : ISS131
- D12-21, 32 : or HSS104
- D22 : RD2, 7ES (B2)
- D22 : or IZ2, 7N (B2)

S2	W5	W6	W7	W8	W11	W12	E6	E7	E8	E10	JB	J40	J123	J129, 132	J130, 131	J133, 136	J134, 137	J143	J145
YES	YES	NO	NO	YES	YES	E20-0459-05	NO	E11-0198-05	YES	YES	YES	YES	NO	NO	YES	NO	NO	NO	
NO	YES	NO	NO	YES	YES	E20-0459-05	NO	E11-0198-05	YES	NO	YES	NO	NO	NO	YES	NO	NO	NO	
NO	NO	YES	YES	NO	NO	E20-0823-05	YES	E11-0189-05	NO	YES	NO	NO	YES	NO	NO	YES	NO	YES	
YES	NO	YES	NO	YES	NO	E20-0823-05	NO	E11-0189-05	YES	NO	NO	NO	NO	YES	NO	NO	NO	NO	

	A	B	C	D	E	F	G	H	J	K
A-34 (E, T, X)	38.5V	39.3V	0V	11.2V	11.9V	25.9V	39.2V	-39.2V	-27.7V	-21.
A-54 (E, T)	45.0V	45.8V	1.1V	11.5V	12.1V	25.9V	45.8V	-45.8V	-27.7V	-21.
A-54 (M, X)	41.0V	41.7V	1.1V	11.2V	11.8V	25.2V	41.8V	-41.8V	-27.0V	-20.

(X11-293X-XX) (A/6)
 (X11-296X-XX) (A/6) SINGAPORE MADE

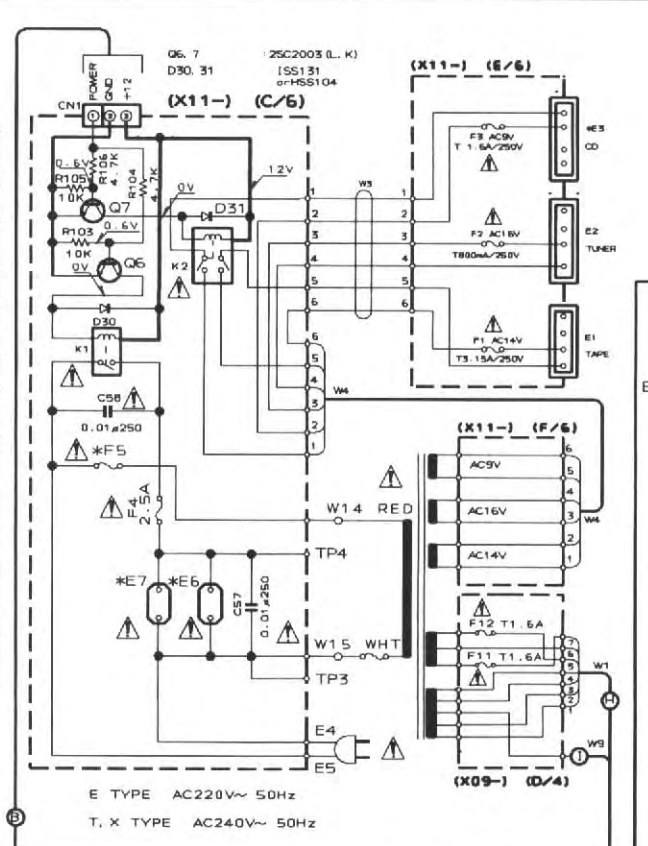
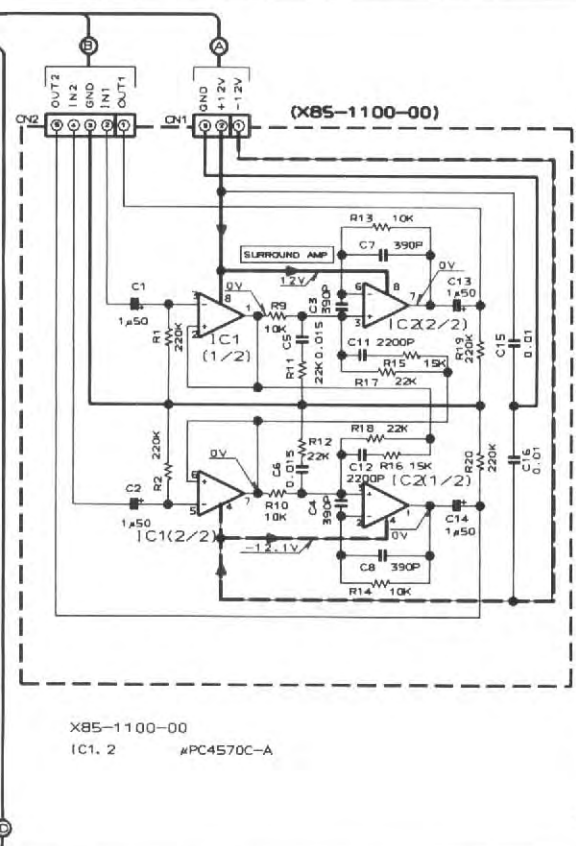
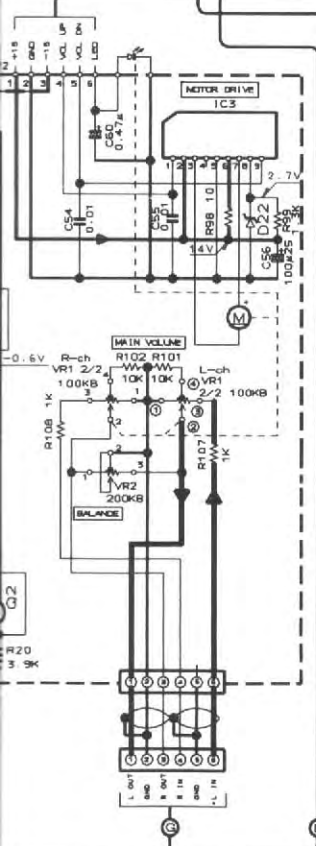
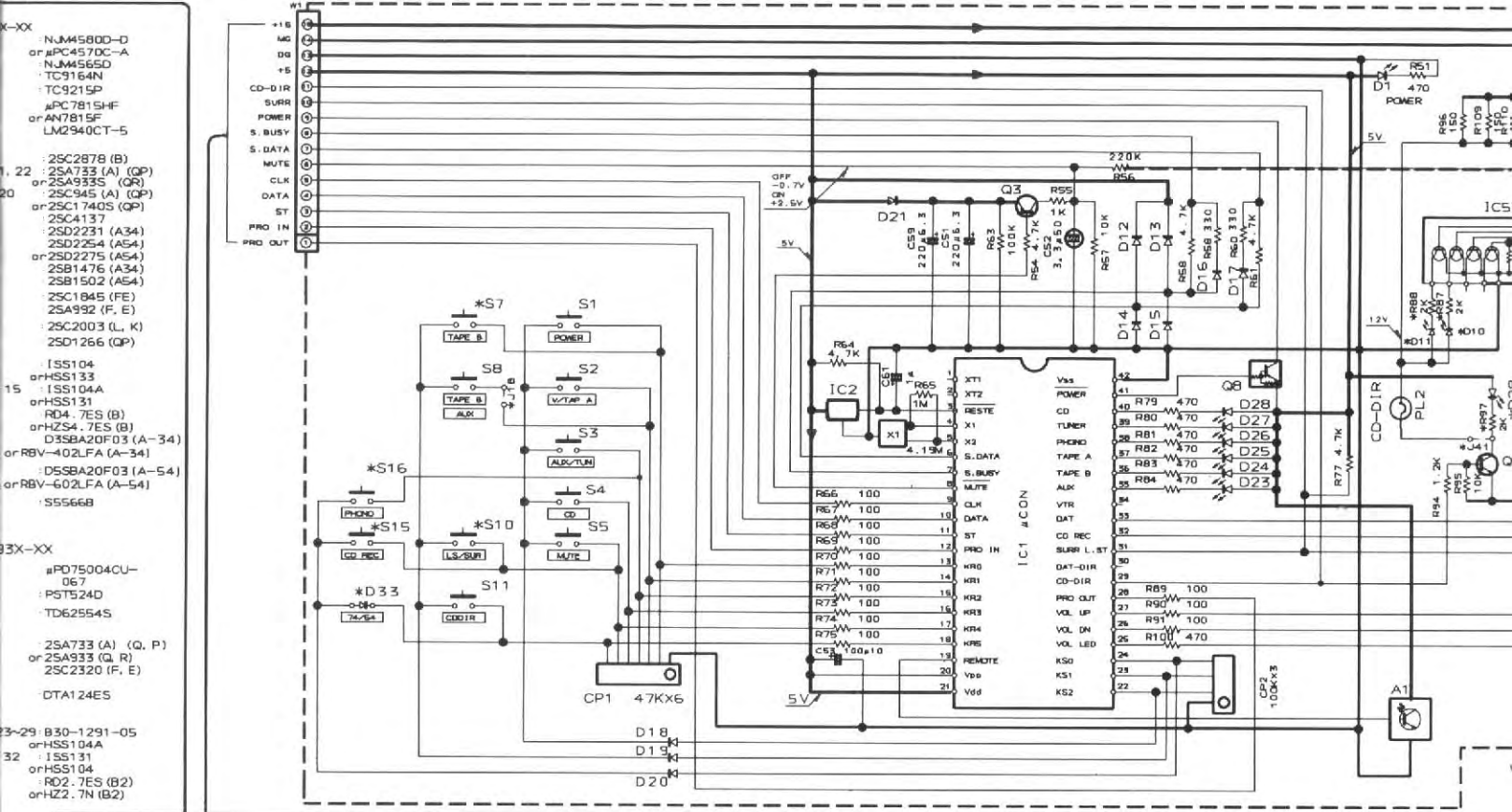

H	J	K	L	M	N	O
-39.2V	-27.7V	-21.0V	-15.6V	10.0V	AC29.2/23.9	AC29.2/23.9
-45.8V	-27.7V	-21.5V	-15.4V	9.8V	AC33.5/27.4	AC33.5/27.4
-41.8V	-27.0V	-20.5V	-15.6V	9.3V	AC30.5	AC30.5

		X11-293X-XX																			
		D10	D11	D29	E3	E6.7	F3	F5	F6	IC5	J41	S10	S15	S17	PL2	R87	R88	R97	W7-13	W14-15	
A-34	E	2-72	NO	NO	YES	YES	E03 010805	1.6A	1A	NO	NO	NO	NO	NO	NO	NO	NO	NO	2K	NO	YES
	T	0-53	NO	NO	YES	YES	E03 010905	1.6A	1A	NO	NO	NO	NO	NO	NO	NO	NO	NO	2K	NO	YES
	X	0-72	NO	NO	YES	YES	NO	1.6A	1A	NO	NO	NO	NO	NO	NO	NO	NO	NO	2K	NO	YES
A-54	E	2-71	YES	NO	NO	NO	E03 010805	NO	1.25	NO	YES	YES	NO	YES	YES	2K	NO	NO	NO	NO	YES
	T	0-52	YES	NO	NO	NO	E03 010905	NO	1.25	NO	YES	YES	NO	YES	YES	2K	NO	NO	NO	NO	YES
	M	0-21	YES	YES	NO	NO	E03 010805	NO	4A	2A	YES	YES	YES	YES	YES	2K	2K	NO	NO	YES	NO
X	0-71	YES	YES	NO	NO	NO	NO	2A	NO	YES	YES	YES	YES	NO	YES	2K	2K	NO	NO	YES	

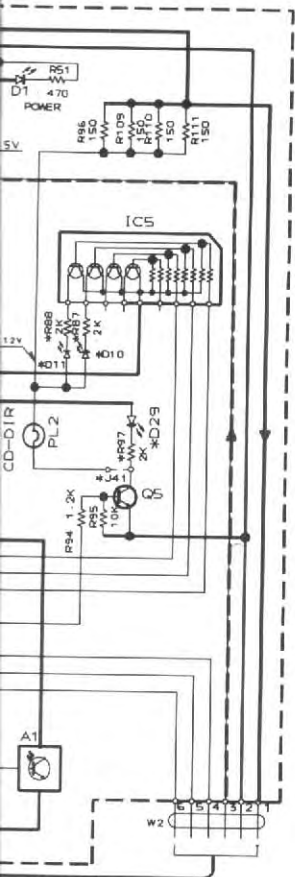

2SA733(A)
2SA992
2SC1845
2SC2003
2SC2320
2SC2878
2SC945(A)

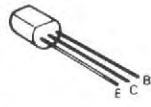

2SD1266

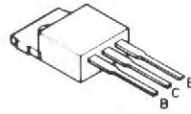

2SB1476*5
2SD2231*5

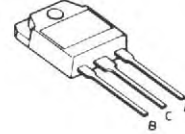

DTA124ES
2SA933S
2SC1740S

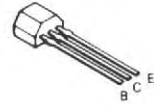

2SC4137



TC9215P

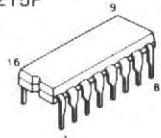

TA8409S
TD62554S

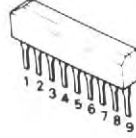

NJM4565D
UPC4570C-A



UPD75004CU-067

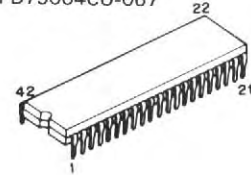

AN7815F
LM2940CT-5.0
UPC7815HF

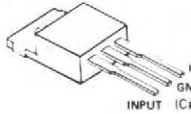

TC9164N

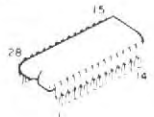

CAUTION: For continued safety, replace safety critical components only with manufacturer's recommended parts (refer to parts list). **⚠** Indicates safety critical components. To reduce the risk of electric shock, leakage-current or resistance measurements shall be carried out (exposed parts are acceptably insulated from the supply circuit) before the appliance is returned to the customer.

DC voltages are as measured with a high impedance meter. Values may vary slightly due to variations in individual instruments or/and units.

Les tensions c.c. doivent être mesurées avec une haute impédance. Les valeurs peuvent différer à cause de variations inhérentes aux appareils et de mesure individuels.

Die angegebenen Gleichspannungswerte wurden mit einem hochohmigen Spannungsmesser gemessen. Die Meßwerte aufgrund von Unterschieden einzelner Instrumenten oder Geräten u. U. geringfügig.

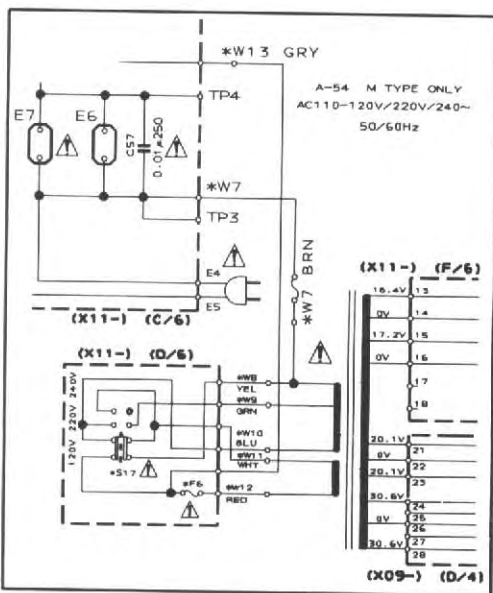

W7	W14
13	15
NO	YES
NO	YES
NO	YES
NO	YES
NO	YES
YES	NO
NO	YES

— SIGNAL LINE
— GND LINE
— +B LINE
— -B LINE



2SA733(A)
2SA992
2SC1845
2SC2003
2SC2320
2SC2878
2SC945(A)

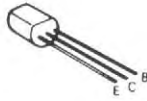

2SD1266

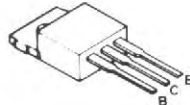

2SB1476*5
2SD2231*5

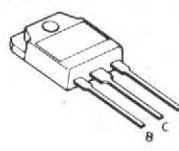

DTA124ES
2SA933S
2SC1740S

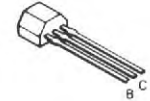

2SC4137



2SB1492
2SD2254



TC9215P

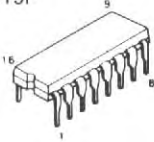

TA8409S
TD62554S

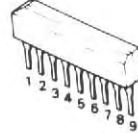

NJM4565D
UPC4570C-A



UPD75004CU-067

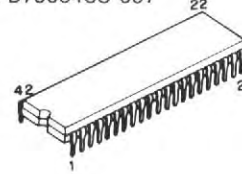

AN7815F
LM2940CT-5.0
UPC7815HF

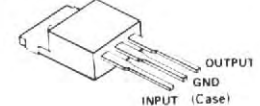

PST529D

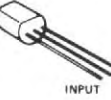

TC9164N

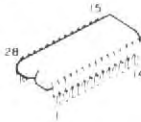

CAUTION: For continued safety, replace safety critical components only with manufacturer's recommended parts (refer to parts list).  Indicates safety critical components. To reduce the risk of electric shock, leakage-current or resistance measurements shall be carried out (exposed parts are acceptably insulated from the supply circuit) before the appliance is returned to the customer.

DC voltages are as measured with a high impedance voltmeter. Values may vary slightly due to variations between individual instruments or/and units.

Les tensions c.c. doivent être mesurées avec un voltmètre à haute impédance. Les valeurs peuvent différer légèrement du fait des variations inhérentes aux appareils et aux instruments de mesure individuels.

Die angegebenen Gleichspannungswerte wurden mit einem hochohmigen Spannungsmesser gemessen. Dabei schwanken die Meßwerte aufgrund von Unterschieden zwischen einzelnen Instrumenten oder Geräten u. U. geringfügig.

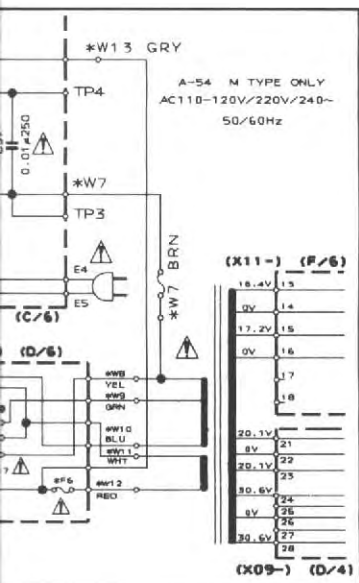

— SIGNAL LINE
— GND LINE
— B LINE
— B LINE

PARTS LIST

※ New Parts

Parts without Parts No. are not supplied.

Les articles non mentionnes dans le Parts No. ne sont pas fournis.

Telle ohne Parts No. werden nicht geliefert.

Ref. No. 参照番号	Address 位置	New Parts 新	Parts No. 部品番号	Description 部品名 / 規格	Desti- nation 仕 向	Re- marks 備考
A-34 (JAPAN MADE)						
601	1A	*	A01-1894-01	METALLIC CABINET		
602	2A	*	A20-6078-02	PANEL		
603	2A	*	B01-0470-01	PANEL ESCUTCHEON		
605	2A	*	B03-2478-04	DRESSING PLATE		
606	2A	*	B03-2661-03	DRESSING PLATE		
607	2A	*	B10-1810-03	FRONT GLASS		
608	2A	*	B11-0232-04	SMOKED FILTER	T	
-			B46-0096-13	WARRANTY CARD	X	
-			B46-0122-13	WARRANTY CARD	E	
-			B46-0143-13	WARRANTY CARD	T	
616	1C		E30-0459-05	AC POWER CORD	E	
616	1C		E30-1341-05	AC POWER CORD	X	
616	1C		E30-1416-05	AC POWER CORD	T	
E6			E03-0114-05	AC OUTLET	X	
617	2A		G13-0439-04	CUSHION		
-		*	H01-8863-04	ITEM CARTON CASE		
-		*	H10-5050-02	POLYSTYRENE FOAMED FIXTURE		
-		*	H10-5051-02	POLYSTYRENE FOAMED FIXTURE		
-			H25-0224-04	PROTECTION BAG (800X400X0.03)		
-			H25-0232-04	PROTECTION BAG (235X350X0.03)		
620	2C		J02-0366-15	FOOT		
621	2C		J02-1040-05	FOOT		
622	1C		J12-0091-05	PIN		
625	1C		J42-0083-05	POWER CORD BUSHING		
-			J61-0307-05	WIRE BAND		
627	2A	*	K29-3981-04	KNOB BASS, TREBLE		
628	2A	*	K29-3741-04	KNOB BALANCE		
629	2A	*	K29-3744-04	KNOB VOLUME		
633	2A, 2B	*	K29-3983-03	KNOB INPUT SELECTOR		
635	2B	*	L07-0141-05	POWER TRANSFORMER	E	
635	2B	*	L07-0142-05	POWER TRANSFORMER	TX	
E	1A		N89-3006-45	BINDING HEAD TAPTITE SCREW		
F	2C		N89-3006-46	BINDING HEAD TAPTITE SCREW		
G	2A, 1C		N89-3008-45	BINDING HEAD TAPTITE SCREW		
H	1B, 2B		N89-3008-46	BINDING HEAD TAPTITE SCREW		
J	2B		N89-4008-45	BINDING HEAD TAPTITE SCREW		
A-34 (SINGAPORE MADE)						
601	1A	*	A01-1894-01	METALLIC CABINET		
602	2A	*	A20-6078-02	PANEL		
603	2A	*	B01-0470-01	PANEL ESCUTCHEON		
605	2A	*	B03-2478-04	DRESSING PLATE		
606	2A	*	B03-2661-03	DRESSING PLATE		
607	2A	*	B10-1810-03	FRONT GLASS		
608	2A	*	B11-0232-04	SMOKED FILTER		
-			B46-0096-13	WARRANTY CARD	X	
-			B46-0122-13	WARRANTY CARD	E	
-			B46-0143-13	WARRANTY CARD	T	
616	1C		E30-0459-05	AC POWER CORD	E	
616	1C		E30-1341-05	AC POWER CORD	X	
616	1C		E30-1416-05	AC POWER CORD	T	

E: Scandinavia & Europe K: USA

P: Canada

5: A-54 J: Japan made

Y: PX (Far East, Hawaii) T: England

M: Other Areas

3: A-34 S: Singapore made

Y: AAFES (Europe)

X: Australia

△ indicates safety critical components.

PARTS LIST

× New Parts

Parts without Parts No. are not supplied.

Les articles non mentionnés dans le Parts No. ne sont pas fournis.

Teile ohne Parts No. werden nicht geliefert.

Ref. No. 参照番号	Address 位置	New Parts 新	Parts No. 部品番号	Description 部品名 / 規格	Desti- nation 仕 向	Re- marks 備考
E6			B03-0114-05	AC OUTLET	X	
617	2A		G13-0439-04	CUSHION		
-		*	H01-8868-04	ITEM CARTON CASE	ET	
-		*	H01-8907-04	ITEM CARTON CASE	X	
-		*	H10-5052-02	POLYSTYRENE FOAMED FIXTURE		
-		*	H10-5053-02	POLYSTYRENE FOAMED FIXTURE		
-			H25-0224-04	PROTECTION BAG (800X400X0.03)		
-			H25-0232-04	PROTECTION BAG (235X350X0.03)		
620	2C		J02-0366-15	FOOT		
621	2C		J02-1040-05	FOOT		
622	1C		J12-0091-05	PIN		
625	1C		J42-0083-05	POWER CORD BUSHING		
-			J61-0307-05	WIRE BAND		
627	2A	*	K29-3981-04	KNOB BASS, TREBLE		
628	2A		K29-3741-04	KNOB BALANCE		
629	2A		K29-3744-04	KNOB VOLUME		
633	2A, 2B	*	K29-3983-03	KNOB INPUT SELECTOR		
635	2B	*	L07-0141-05	POWER TRANSFORMER	E	
635	2B	*	L07-0142-05	POWER TRANSFORMER	TX	
E	1A		N89-3006-45	BINDING HEAD TAPTITE SCREW		
F	2C		N89-3006-46	BINDING HEAD TAPTITE SCREW		
G	2A, 1C		N89-3008-45	BINDING HEAD TAPTITE SCREW		
H	1B, 2B		N89-3008-46	BINDING HEAD TAPTITE SCREW		
J	2B		N89-4008-45	BINDING HEAD TAPTITE SCREW		
A-54 (JAPAN MADE)						
601	1A	*	A01-1894-01	METALLIC CABINET		
602	2A	*	A20-6076-02	PANEL	ET	
602	2A	*	A20-6077-02	PANEL	MX	
603	2A	*	B01-0469-01	PANEL ESCUTCHEON		
605	2A		B03-2478-04	DRESSING PLATE		
606	2A	*	B03-2661-03	DRESSING PLATE		
607	2A	*	B10-1809-03	FRONT GLASS		
608	2A	*	B11-0232-04	SMOKED FILTER		
-			B46-0096-13	WARRANTY CARD	X	
-			B46-0122-13	WARRANTY CARD	E	
-			B46-0143-13	WARRANTY CARD	T	
616	1C		E30-0459-05	AC POWER CORD	EM	
616	1C		E30-1341-05	AC POWER CORD	X	
616	1C		E30-1416-05	AC POWER CORD	T	
E6			E03-0114-05	AC OUTLET	X	
617	2A		G13-0439-04	CUSHION		
-		*	H01-8862-04	ITEM CARTON CASE		
-		*	H10-5050-02	POLYSTYRENE FOAMED FIXTURE		
-		*	H10-5051-02	POLYSTYRENE FOAMED FIXTURE		
-			H25-0224-04	PROTECTION BAG (800X400X0.03)		
-			H25-0232-04	PROTECTION BAG (235X350X0.03)	ETX	
620	2C		J02-0366-15	FOOT		
621	2C		J02-1040-05	FOOT		
622	1C		J12-0091-05	PIN		
625	1C		J42-0083-05	POWER CORD BUSHING		
-			J61-0307-05	WIRE BAND		

E: Scandinavia & Europe K: USA P: Canada
 Y: PX(Far East, Hawaii) T: England M: Other Areas
 Y: AAFES(Europe) X: Australia

5: A-54 J: Japan made
 3: A-34 S: Singapore made

PARTS LIST

× New Parts

Parts without Parts No. are not supplied.

Les articles non mentionnés dans le Parts No. ne sont pas fournis.

Teile ohne Parts No. werden nicht geliefert.

Ref. No. 参照番号	Address 位置	New Parts 新	Parts No. 部品番号	Description 部品名 / 規格	Desti- nation 仕向	Re- marks 備考
627	2A	*	K29-3981-04	KNØB BASS, TREBLE		
628	2A		K29-3741-04	KNØB BALANCE		
629	2A		K29-3744-04	KNØB VOLUME		
633	2A, 2B	*	K29-3983-03	KNØB INPUT SELECTOR		
636	2A	*	K27-2021-04	KNØB SPEAKERS		
635	2B	*	L07-0138-05	POWER TRANSFORMER	E	
635	2B	*	L07-0139-05	POWER TRANSFORMER	T	
635	2B	*	L07-0140-05	POWER TRANSFORMER	M	
635	2B	*	L07-0211-05	POWER TRANSFORMER	X	
C	2B		N30-3006-46	PAN HEAD MACHINE SCREW		
E	1A		N89-3006-45	BINDING HEAD TAPTITE SCREW		
F	2C		N89-3006-46	BINDING HEAD TAPTITE SCREW		
G	2A, 1C		M89-3008-45	BINDING HEAD TAPTITE SCREW		
H	1B, 2B		N89-3008-46	BINDING HEAD TAPTITE SCREW		
J	2B		N89-4008-45	BINDING HEAD TAPTITE SCREW		
A-54 (SINGAPORE MADE)						
601	1A	*	A01-1894-01	METALLIC CABINET	ET	
602	2A	*	A20-6076-02	PANEL	MX	
602	2A	*	A20-6077-02	PANEL		
603	2A	*	B01-0469-01	PANEL ESCUTCHEON		
605	2A	*	B03-2478-04	DRESSING PLATE		
606	2A	*	B03-2661-03	DRESSING PLATE		
607	2A	*	B10-1809-03	FRONT GLASS		
608	2A	*	B11-0232-04	SMOKED FILTER		
-			B46-0096-13	WARRANTY CARD	X	
-			B46-0122-13	WARRANTY CARD	E	
-			B46-0143-13	WARRANTY CARD	T	
616	1C		E30-0459-05	AC POWER CORD	EM	
616	1C		E30-1341-05	AC POWER CORD	X	
616	1C		E30-1416-05	AC POWER CORD	T	
E6			E03-0114-05	AC OUTLET	X	
617	2A		G13-0439-04	CUSHION		
-		*	H01-8866-04	ITEM CARTON CASE	ET	
-		*	H01-8867-04	ITEM CARTON CASE	MX	
-		*	H10-5052-02	POLYSTYRENE FOAMED FIXTURE		
-		*	H10-5053-02	POLYSTYRENE FOAMED FIXTURE		
-			H25-0224-04	PROTECTION BAG (800X400X0.03)		
-			H25-0232-04	PROTECTION BAG (235X350X0.03)	ETX	
620	2C		J02-0366-15	FOOT		
621	2C		J02-1040-05	FOOT		
622	1C		J12-0091-05	PIN		
625	1C		J42-0083-05	POWER CORD BUSHING		
-			J61-0307-05	WIRE BAND		
626	2A	*	K27-2021-04	KNØB SPEAKERS		
627	2A	*	K29-3981-04	KNØB BASS, TREBLE		
628	2A		K29-3741-04	KNØB BALANCE		
629	2A		K29-3744-04	KNØB VOLUME		
633	2A, 2B	*	K29-3983-03	KNØB INPUT SELECTOR		
635	2B	*	L07-0138-05	POWER TRANSFORMER	E	
635	2B	*	L07-0139-05	POWER TRANSFORMER	T	
635	2B	*	L07-0140-05	POWER TRANSFORMER	M	
635	2B	*	L07-0211-05	POWER TRANSFORMER	X	

E: Scandinavia & Europe K: USA P: Canada
 Y: PX (Far East, Hawaii) T: England M: Other Areas
 Y: AAFES (Europe) X: Australia

5: A-54 J: Japan made
 3: A-34 S: Singapore made

⚠ indicates safety critical components.

PARTS LIST

* New Parts

Parts without Parts No. are not supplied.

Les articles non mentionnés dans le Parts No. ne sont pas fournis.

Telle ohne Parts No. werden nicht geliefert.

Ref. No. 参照番号	Address 位置	New Parts 新	Parts No. 部品番号	Description 部品名 / 規格	Desti- nation 仕 向	Re- marks 備考
C	2B		N30-3006-46	PAN HEAD MACHINE SCREW		
E	1A		N89-3006-45	BINDING HEAD TAPTITE SCREW		
F	2C		N89-3006-46	BINDING HEAD TAPTITE SCREW		
G	2A, 1C		N89-3008-45	BINDING HEAD TAPTITE SCREW		
H	1B, 2B		N89-3008-46	BINDING HEAD TAPTITE SCREW		
J	2B		N89-4008-45	BINDING HEAD TAPTITE SCREW		
AUDIO UNIT (X09-319X-XX : J, X09-322X-XX : S)						
C1 ,2			C91-0749-05	CERAMIC 220PF K		
C3 ,4			CE04KW1V100M	ELECTRØ 10UF 35WV		J
C3 ,4			CE04LW1V100M	ELECTRØ 10UF 35WV		S
C5 ,6			CE04KW1A101M	ELECTRØ 100UF 10WV		J
C5 ,6			CE04LW1A101M	ELECTRØ 100UF 10WV		S
C7 ,8			CK45FB1H561K	CERAMIC 560PF K		
C9 ,10			CF92FV1H123J	MF 0.012UF J		
C11 ,12			CF92FV1H332J	MF 3300PF J		
C13 ,14			CE04KW1V100M	ELECTRØ 10UF 35WV		J
C13 ,14			CE04LW1V100M	ELECTRØ 10UF 35WV		S
C15 ,16			CE04KW1E470M	ELECTRØ 47UF 25WV		J
C15 ,16			CE04LW1E470M	ELECTRØ 47UF 25WV		S
C17			CK45FF1H103Z	CERAMIC 0.010UF Z		
C21 -32			C91-0749-05	CERAMIC 220PF K		
C33 ,34			CE04KW1V4R7M	ELECTRØ 4.7UF 35WV		J
C33 ,34			CE04LW1V4R7M	ELECTRØ 4.7UF 35WV		S
C35 ,36			CC45FSL1H221J	CERAMIC 220PF J		
C37 ,38			CE04KW1C220M	ELECTRØ 22UF 16WV		J
C37 ,38			CE04LW1C220M	ELECTRØ 22UF 16WV		S
C39 -41			CK45FF1H103Z	CERAMIC 0.010UF Z		
C42 ,43			CK45FB1H102K	CERAMIC 0.001UF K		
C45 ,46			C91-0749-05	CERAMIC 220PF K		
C48 ,49			C91-0769-05	CERAMIC 0.01UF K	MX	5
C50 ,51			CK45FB1H471K	CERAMIC 470PF K		
C61 ,62			CE04KW1C220M	ELECTRØ 22UF 16WV		J
C61 ,62			CE04LW1C220M	ELECTRØ 22UF 16WV		S
C63 ,64			CK45FF1H103Z	CERAMIC 0.010UF Z		
C67 -70			CF92FV1H104J	MF 0.10UF J	ET	5
C67 -70			CF92FV1H104J	MF 0.10UF J		3
C67 ,68			CF92FV1H473J	MF 0.047UF J	MX	5
C71 ,72			CK45FB1H222K	CERAMIC 2200PF K		
C73			CE04KW1H4R7M	ELECTRØ 4.7UF 50WV		J
C73			CE04LW1H4R7M	ELECTRØ 4.7UF 50WV		S
C74			CE04KW1A221M	ELECTRØ 220UF 10WV		J
C74			CE04LW1A221M	ELECTRØ 220UF 10WV		S
C75			CE04KW1C220M	ELECTRØ 22UF 16WV		J
C75			CE04LW1C220M	ELECTRØ 22UF 16WV		S
C77 ,78			CC45FSL1H221J	CERAMIC 220PF J		
C79 -82			C91-0757-05	CERAMIC 1000PF K	ET	5
C79 ,80			C91-0757-05	CERAMIC 1000PF K	ET	3
C83 ,84			CK45FB1H561K	CERAMIC 560PF K	ET	
C87 ,88			CK45FF1H103Z	CERAMIC 0.010UF Z		
C91			CE04KW1C331M	ELECTRØ 330UF 16WV		J
C91			CE04LW1C331M	ELECTRØ 330UF 16WV		S
C92			CE04KW1C101M	ELECTRØ 100UF 16WV		J
C92			CE04LW1C101M	ELECTRØ 100UF 16WV		S
C93 ,94			CF92FV1H104J	MF 0.10UF J		

E: Scandinavia & Europe K: USA P: Canada
 Y: PX (Far East, Hawaii) T: England M: Other Areas
 Y: AAFES (Europe) X: Australia

5: A-54 J: Japan made
 3: A-34 S: Singapore made

△ indicates safety critical components.

PARTS LIST

× New Parts

Parts without Parts No. are not supplied.

Les articles non mentionnés dans le Parts No. ne sont pas fournis.

Teile ohne Parts No. werden nicht geliefert.

Ref. No. 参照番号	Address 位置	New Parts 新	Parts No. 部品番号	Description 部品名 / 規格	Desti- nation 仕 向	Re- marks 備考
C95			CE04KW1V102M	ELECTRØ 1000UF 35WV		J
C95			CE04LW1V102M	ELECTRØ 1000UF 35WV		S
C96			CF92FV1H103J	MF 0.010UF J		
C97			CE04KW1E470M	ELECTRØ 47UF 25WV		J
C97			CE04LW1E470M	ELECTRØ 47UF 25WV		S
C98			CE04KW1V471M	ELECTRØ 470UF 35WV		J
C98			CE04LW1V471M	ELECTRØ 470UF 35WV		S
C99 ,100			CK45FF1H103Z	CERAMIC 0.010UF Z		
C101,102			C90-1588-05	ELECTRØ 4700UF 50WV		3
C101,102			C90-1790-05	ELECTRØ 4700UF 56WV		5
C103,104			CK45FF1H103Z	CERAMIC 0.010UF Z		
C105			CF92FV1H104J	MF 0.10UF J		
C106			CE04KW1H010M	ELECTRØ 1.0UF 50WV		
C107			CF92FV1H104J	MF 0.10UF J		
E1			E13-0235-05	PHONØ JACK PHONØ		3
E2 ,3			E13-0634-05	PHONØ JACK CD, TUN, AUX TAPE, GEQ		3
E4			E13-0235-05	PHONØ JACK GEQ IN		3
E5		*	E08-0311-05	RECEPTACLE SYSTEM CONTROL		
E6			E20-0459-05	LOCK TERMINAL BOARD SPEAKERS		3
E6			E20-0823-05	LOCK TERMINAL BOARD SPEAKERS		5
E7			E13-0254-05	PHONØ JACK SURROUND SPEAKER	MX	5
E8			E11-0189-05	PHONE JACK PHONES		5
E8			E11-0198-05	PHONE JACK PHONES		3
F11 ,12			F53-0018-05	FUSE		
L1 ,2			L39-0085-05	PHASE-COMPENSATION COIL		
A	1B		N09-0333-05	TAPPING SCREW (3X12)		
B	2C		N09-1445-05	SET SCREW (M3X8)		
D	1B		N35-3008-45	BINDING HEAD MACHINE SCREW		
G	1B		N89-3008-45	BINDING HEAD TAPTITE SCREW		
H	1B		N89-3008-46	BINDING HEAD TAPTITE SCREW		
CP1 ,2			R90-0187-05	MULTI-COMP 0.22X2 K 5W		
CP1 ,2		*	R90-0840-05	COMPOSITE ELEMENTS		
R17 ,18			RD14AB2E100J	FL-PROOF RD 10 J 1/4W		J
R17 ,18			RD14NB2E100J	RD 10 J 1/4W		S
R83 -86			RD14AB2E4R7J	FL-PROOF RD 4.7 J 1/4W		J
R83 -86			RD14NB2E4R7J	RD 4.7 J 1/4W		S
R93 ,94			RS14DB3D100J	FL-PROOF RS 10 J 2W		J
R93 ,94			RS14KB3D100J	FL-PROOF RS 10 J 2W		S
R107			RS14DB3A100J	FL-PROOF RS 10 J 1W		J
R107			RS14KB3A100J	FL-PROOF RS 10 J 1W		S
R108			RD14AB2E100J	FL-PROOF RD 10 J 1/4W		J
R108			RD14NB2E100J	RD 10 J 1/4W		S
R109,110			RS14DB3A331J	FL-PROOF RS 330 J 1W		J
R109,110			RS14KB3A331J	FL-PROOF RS 330 J 1W		S
R116			RD14AB2E2R2J	FL-PROOF RD 2.2 J 1/4W		J
R116			RD14NB2E2R2J	RD 2.2 J 1/4W		S
R117			RS14DB3A271J	FL-PROOF RS 270 J 1W		J
R117			RS14KB3A271J	FL-PROOF RS 270 J 1W		S
R118			RS14DB3D101J	FL-PROOF RS 100 J 2W		J
R118			RS14KB3D101J	FL-PROOF RS 100 J 2W		S
R119			RS14DB3D221J	FL-PROOF RS 220 J 2W		J
R119			RS14KB3D221J	FL-PROOF RS 220 J 2W		S
R128			RS14DB3A560J	FL-PROOF RS 56 J 1W		J

E: Scandinavia & Europe K: USA P: Canada
 Y: PX(Far East, Hawaii) T: England M: Other Areas
 Y: AAFES(Europe) X: Australia

5: A-54 J: Japan made
 3: A-34 S: Singapore made

⚠ indicates safety critical components.

PARTS LIST

× New Parts

Parts without Parts No. are not supplied.

Les articles non mentionnés dans le Parts No. ne sont pas fournis.

Teile ohne Parts No. werden nicht geliefert.

Ref. No. 参照番号	Address 位置	New Parts 新	Parts No. 部品番号	Description 部品名 / 規格	Desti- nation 仕 向	Re- marks 備考
R128			RS14KB3A560J	FL-PROOF RS 56 J 1W		S
K1			S51-2093-05	MAGNETIC RELAY		
S1		*	S42-2176-05	MULTIPLE PUSH SWITCH SPEAKERS	ET	5
S2			S31-2136-05	SLIDE SWITCH IMPEDANCE SELECT		5
S2			S31-2136-05	SLIDE SWITCH IMPEDANCE SELECT		3
D1 -9			HSS104	DIODE		
D1 -9			1SS133	DIODE		
D11 -13			HSS104A	DIODE		
D11 -13			1SS131	DIODE		
D14			HZS4.7N(B)	ZENER DIODE		
D14			RD4.7ES(B)	ZENER DIODE		
D15			HSS104A	DIODE		
D15			1SS131	DIODE		
D16			D3SBA20F03	DIODE		3
D16			D5SBA20F03	DIODE		5
D16			RBV-402LFA	DIODE		3
D16			RBV-602LFA	DIODE		5
D17 -20			S5566B	DIODE		
IC1			NJM4580D-D	IC		
IC1			UPC4570C-A	IC		
IC2			NJM4565D	IC(OP AMP X2)		
IC3			TC9164N	IC(16CH BILATERAL SELECTOR SW)		
IC4			TC9215P	IC(ANALOG SWITCH X 6)		
IC5			AN7815F	IC(VOLTAGE REGULATOR/ +15V)		
IC5			UPC7815HF	IC(VOLTAGE REGULATOR/ +15V)		
IC6			LM2940CT-5.0	IC(LOW VOLTAGE REGULATOR)		
Q1 ,2			2SC2878(B)	TRANSISTOR		
Q3			2SA733(A)(Q,P)	TRANSISTOR		
Q3			2SA933S(Q,R)	TRANSISTOR		
Q4			2SC1740S(Q,R)	TRANSISTOR		
Q4			2SC945(A)(Q,P)	TRANSISTOR		
Q5			2SA733(A)(Q,P)	TRANSISTOR		
Q5			2SA933S(Q,R)	TRANSISTOR		
Q7 ,8			2SC4137	TRANSISTOR		
Q9 ,10			2SD2231*5	TRANSISTOR		3
Q9 ,10		*	2SD2254	TRANSISTOR	MX	5
Q9 ,10		*	2SD2275	TRANSISTOR	ET	5
Q11 ,12			2SB1476*5	TRANSISTOR		3
Q11 ,12		*	2SB1492	TRANSISTOR	MX	5
Q11 ,12		*	2SB1502	TRANSISTOR	ET	5
Q13 ,14			2SC1845(F,E)	TRANSISTOR		
Q17			2SA992(F,E)	TRANSISTOR		
Q18			2SC2003(L,K)	TRANSISTOR		
Q19 ,20			2SC1740S(Q,R)	TRANSISTOR		
Q19 ,20			2SC945(A)(Q,P)	TRANSISTOR		
Q21 ,22			2SA733(A)(Q,P)	TRANSISTOR		
Q21 ,22			2SA933S(Q,R)	TRANSISTOR		
Q23			2SD1266(Q,P)	TRANSISTOR		
CONTROL UNIT (X11-293X-XX : J, X11-296X-XX : S)						
640	2B	*	A33-0117-04	REFLECTOR		5
641	2B	*	B11-0233-04	SMOKED FILTER		5
D1			B30-1291-05	LED		
D10			B30-1291-05	LED	ET	5

E: Scandinavia & Europe K: USA P: Canada
 Y: PX(Far East, Hawaii) T: England M: Other Areas
 Y: AAFES(Europe) X: Australia

5: A-54 J: Japan made
 3: A-34 S: Singapore made

△ indicates safety critical components.

PARTS LIST

× New Parts

Parts without Parts No. are not supplied.

Les articles non mentionnes dans le Parts No. ne sont pas fournis.

Telle ohne Parts No. werden nicht geliefert.

Ref. No. 参照番号	Address 位置	New Parts 新	Parts No. 部品番号	Description 部品名 / 規格	Desti- nation 仕向	Re- marks 備考
D10 ,11			B30-1291-05	LED	MX	5
D23 -28			B30-1291-05	LED		5
D23 -29			B30-1291-05	LED		3
PL2		*	B30-1292-05	LAMP (12V 100MA)		5
C1 ,2			CE04KW1H3R3M	ELECTRØ 3.3UF 50WV		J
C1 ,2			CE04LW1H3R3M	ELECTRØ 3.3UF 50WV		S
C3 ,4			CF92FV1H221J	MF 220PF J		
C5 ,6			CF92FV1H561J	MF 560PF J		
C7 ,8			CF92FV1H683J	MF 0.068UF J		
C9 ,10			CF92FV1H561J	MF 560PF J		
C11 ,12			CE04KW1V100M	ELECTRØ 10UF 35WV		J
C11 ,12			CE04LW1V100M	ELECTRØ 10UF 35WV		S
C13 ,14			CF92FV1H203J	MF 0.020UF J		
C15 ,16			CE04KW1H4R7M	ELECTRØ 4.7UF 50WV		J
C15 ,16			CE04LW1H4R7M	ELECTRØ 4.7UF 50WV		S
C17 ,18			CE04KW1E470M	ELECTRØ 47UF 25WV		J
C17 ,18			CE04LW1E470M	ELECTRØ 47UF 25WV		S
C51			CE04JW0J221M	ELECTRØ 220UF 6.3WV		
C52			C90-1283-05	ELECTRØ 3.3UF 50WV		
C53			CE04JW1A101M	ELECTRØ 100UF 10WV		
C54 ,55			CK45FF1H103Z	CERAMIC 0.010UF Z		
C56			CE04KW1E101M	ELECTRØ 100UF 25WV		J
C56			CE04LW1E101M	ELECTRØ 100UF 25WV		S
C57 ,58			C91-0971-05	FILM 0.01UF 250WV		
C59			CE04JW0J221M	ELECTRØ 220UF 6.3WV		
C60			CE04KW1HR47M	ELECTRØ 0.47UF 50WV		J
C60			CE04LW1HR47M	ELECTRØ 0.47UF 50WV		S
C61			CE04JW1H010M	ELECTRØ 1.0UF 50WV		
E1			E08-0411-05	RECTANGULAR RECEPTACLE DECK		
E2		*	E08-0414-05	RECTANGULAR RECEPTACLE TUNER		
E3		*	E08-0415-05	RECTANGULAR RECEPTACLE CD		
E6 ,7			E03-0108-05	AC OUTLET	EM	5
E6 ,7			E03-0108-05	AC OUTLET	E	3
E6 ,7			E03-0109-05	AC OUTLET	T	
F1		*	F53-0021-05	FUSE		
F2		*	F53-0015-05	FUSE		
F3		*	F53-0018-05	FUSE		3
F4			F05-2525-05	FUSE (SEMKØ) (250V T2.5A)		
F5			F05-1222-05	FUSE (SEMKØ) (250V T1.25A)	ET	5
F5			F05-4025-05	FUSE (SEMKØ) (250V T4A)	M	5
F5			F06-1022-05	FUSE		3
F5			F06-2021-05	FUSE (SEMKØ) (250V T2A)	X	5
F6			F06-2021-05	FUSE (SEMKØ) (250V T2A)	M	5
645	1B		J13-0075-05	FUSE CLIP		
X1			L78-0218-05	RESONATOR 4.19MHz		
CP1			R90-0819-05	MULTIPLE RESISTØR		
CP2			R90-0850-05	MULTIPLE RESISTØR		
VR1		*	R29-5045-05	POTENTIØMETER MASTER VØLUME		
VR2		*	R05-5035-05	POTENTIØMETER BALANCE		
VR3 ,4		*	R06-5198-05	POTENTIØMETER BASS, TREBLE		
K1			S51-1052-05	MAGNETIC RELAY		
K2			S51-2094-05	MAGNETIC RELAY		

E: Scandinavia & Europe K: USA P: Canada
 Y: PX(Far East, Hawaii) T: England M: Other Areas
 Y: AAFES(Europe) X: Australia

5: A-54 J: Japan made
 3: A-34 S: Singapore made

⚠ indicates safety critical components.

PARTS LIST

× New Parts

Parts without Parts No. are not supplied.

Les articles non mentionnes dans le Parts No. ne sont pas fournis.

Teile ohne Parts No. werden nicht geliefert.

Ref. No. 参照番号	Address 位置	New Parts 新	Parts No. 部品番号	Description 部品名 / 規格	Desti- nation 仕向	Re- marks 備考
S1 -5 S7 ,8 S10 ,11 S11 S11			S40-1064-05 S40-1064-05 S40-1064-05 S40-1064-05 S40-1064-05	PUSH SWITCH PUSH SWITCH PUSH SWITCH PUSH SWITCH PUSH SWITCH	MX ET	5 5 3
S15 ,16 S16 S17			S40-1064-05 S40-1064-05 S31-2322-05	PUSH SWITCH PUSH SWITCH SLIDE SWITCH	M	5 3 5
D12 -21 D12 -21 D22 D22 D30 ,31			HSS104 1SS133 HZS2.7N(B2) RD2.7ES(B2) HSS104	DIODE DIODE ZENER DIODE ZENER DIODE DIODE		
D30 ,31 IC1 IC2 IC3 IC4		*	1SS133 UPD75004CU-067 PST529D TA8409S UPC4570C-A	DIODE IC(MICROPROCESSOR) IC IC(MOTOR CONTROL) IC		
IC5 Q1 ,2 Q3 Q3 Q5			TD62554S 2SC1845(F,E) 2SA733(A)(Q,P) 2SA933S(Q,R) 2SC2320(E,F)	IC(4CH TRANSISTOR ARRAY) TRANSISTOR TRANSISTOR TRANSISTOR TRANSISTOR		5
Q6 ,7 Q8			2SC2003(L,K) DTA124ES	TRANSISTOR DIGITAL TRANSISTOR		
A1 A1		*	W02-1043-05 W02-1046-05	OPTIC RECEIVING MODULE ELECTRIC CIRCUIT MODULE		
PRE AMPLIFIER UNIT (X85-1100-00)						
C1 ,2 C3 C4 C5 ,6 C7 -10			CE04KW1H010M CK45FB1H391K CK45FB1H391K CF92FV1H153J CK45FB1H391K	ELECTRO 1.0UF 50WV CERAMIC 390PF K CERAMIC 390PF K MF 0.015UF J CERAMIC 390PF K	MX MX MX MX MX	5 5 5 5 5
C11 ,12 C13 ,14 C15 ,16			CK45FB1H222K CE04KW1H010M CK45FF1H103Z	CERAMIC 2200PF K ELECTRO 1.0UF 50WV CERAMIC 0.010UF Z	MX MX MX	5 5 5
IC1 ,2			UPC4570C-A	IC	MX	5
MAIN AMPLIFIER UNIT (X85-116X-XX : J, X85-117X-XX : S)						
C1 ,2 C1 ,2 C3 ,4 C5 ,6 C5 ,6			CE04KW1H010M CE04LW1H010M CC45FSL1H221J CE04KW1A101M CE04LW1H101M	ELECTRO 1.0UF 50WV ELECTRO 1.0UF 50WV CERAMIC 220PF J ELECTRO 100UF 10WV ELECTRO 100UF 50WV		J S J S
C7 ,8 C9 ,10 C11 -14 C15 ,16 C17 ,18			CC45FSL1H680J CC45FSL1H020C CC45FSL1H680J CC45FSL1H221J CE04KW1H470M	CERAMIC 68PF J CERAMIC 2.0PF C CERAMIC 68PF J CERAMIC 220PF J ELECTRO 47UF 50WV		J
C17 ,18 C20 C20 C21 C21			CE04LW1H470M CE04KW1E330M CE04LW1E330M CE04KW1H2R2M CE04LW1H2R2M	ELECTRO 47UF 50WV ELECTRO 33UF 25WV ELECTRO 33UF 25WV ELECTRO 2.2UF 50WV ELECTRO 2.2UF 50WV		S J S J S

E: Scandinavia & Europe K: USA P: Canada
Y: PX (Far East, Hawaii) T: England M: Other Areas
Y: AAFES (Europe) X: Australia

5: A-54 J: Japan made
3: A-34 S: Singapore made

indicates safety critical components.

PARTS LIST

× New Parts

Parts without Parts No. are not supplied.

Les articles non mentionnés dans le Parts No. ne sont pas fournis.

Teile ohne Parts No. werden nicht geliefert.

Ref. No. 参照番号	Address 位置	New Parts 新	Parts No. 部品番号	Description 部品名 / 規格	Desti- nation 仕 向	Re- marks 備考
R15 ,16			RD14AB2E271J	FL-PROOF RD 270 J 1/4W		J
R15 ,16			RD14GB2E271J	FL-PROOF RD 270 J 1/4W		S
R21 -24			RD14AB2E221J	FL-PROOF RD 220 J 1/4W		J
R21 -24			RD14GB2E221J	FL-PROOF RD 220 J 1/4W		S
R25 ,26			RD14AB2E470J	FL-PROOF RD 47 J 1/4W		J
R25 ,26			RD14GB2E470J	FL-PROOF RD 47 J 1/4W		S
D1 ,2			HSS104	DIODE		
D1 ,2			1SS133	DIODE		
Q1 -4			2SA992(F, E)	TRANSISTOR		
Q5 -8			2SC1845(F, E)	TRANSISTOR		
Q9 ,10			2SA992(F, E)	TRANSISTOR		

E: Scandinavia & Europe K: USA P: Canada
 Y: PX(Far East, Hawaii) T: England M: Other Areas
 Y: AAFES(Europe) X: Australia

5: A-54 J: Japan made
 3: A-34 S: Singapore made

 indicates safety critical components.

REMOTE CONTROL UNIT

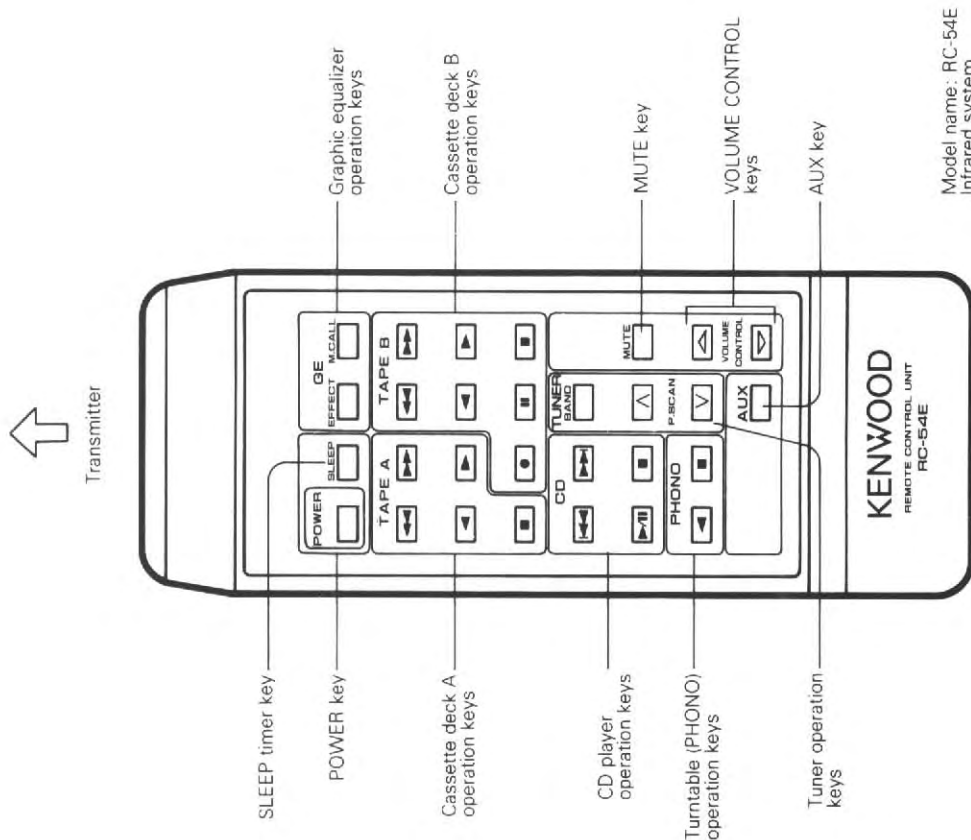
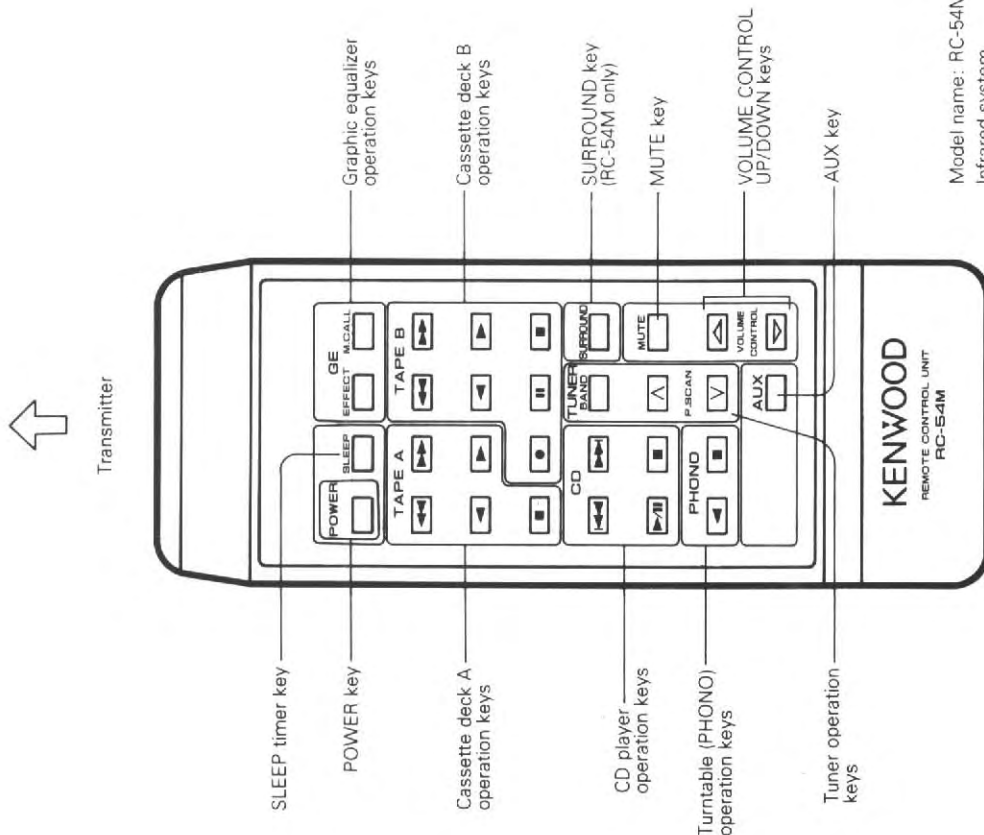

SPECIFICATIONS

A-34

Continuous power output	
(DIN) at 1 kHz 8 Ω:.....	40 W+40 W
(IEC/NF) at 8 Ω:.....	40 W+40 W
Total harmonic distortion	
at 1/2 rated power:.....	0.02%
Signal to noise ratio (IHF '66)	
PHONO (MM):.....	72 dB
CD, TUNER, AUX, TAPE: .	96 dB
Signal to noise ratio (DIN at 50 mW output)	
PHONO (MM):.....	58 dB
CD, TUNER, AUX, TAPE:..	60 dB
Input sensitivity/ Impedance	
PHONO (MM):.....	2.5 mV/47 kΩ
CD, TUNER, AUX, TAPE:..	200 mV/47 kΩ
Frequency response	
(20 Hz to 50,000 Hz):.....	+0 dB, -3 dB
Tone controls	
BASS:.....	±10 dB (at 100 Hz)
TREBLE:.....	±10 dB (at 10 kHz)
Output level/impedance	
TAPE REC:.....	200 mV/3.3 kΩ

General

Power consumption:	140 W (IEC)
Dimension:	W: 360 mm
	H: 129 mm
	D: 375 mm
Weight (net):	6.9 kg

A-54

Continuous power output	
(DIN) at 1 kHz 8 Ω:.....	55 W+55 W
(IEC/NF) at 8 Ω:.....	55 W+55 W
Total harmonic distortion	
at 1/2 rated power:.....	0.02%
Signal to noise ratio (IHF '66)	
PHONO (MM):.....	76 dB
CD, TUNER, AUX, TAPE: .	96 dB
Signal to noise ratio (DIN at 50 mW output)	
PHONO (MM):.....	58 dB
CD, TUNER, AUX, TAPE:..	60 dB
Input sensitivity/ Impedance	
PHONO (MM):.....	2.5 mV/47 kΩ
CD, TUNER, AUX, TAPE:..	200 mV/47 kΩ
Frequency response	
(20 Hz to 50,000 Hz):.....	+0 dB, -3 dB
Tone controls	
BASS:.....	±10 dB (at 100 Hz)
TREBLE:.....	±10 dB (at 10 kHz)
Output level/impedance	
TAPE REC:.....	200 mV/3.3 kΩ

General

Power consumption:	170 W (IEC)
Dimension:	W: 360 mm
	H: 129 mm
	D: 375 mm
Weight (net):	7.3 kg

Note:

KENWOOD follows a policy of continuous advancements in development. For this reason specifications may be changed without notice.

KENWOOD CORPORATION

Shionogi Shibuya Building, 17-5, 2-chome Shibuya, Shibuya-ku, Tokyo 150, Japan

KENWOOD U.S.A. CORPORATION

2201 East Dominguez Street, Long Beach, CA 90810;
550 Clark Drive, Mount Olive, NJ 07828, U.S.A.

KENWOOD ELECTRONICS CANADA INC.

P.O. BOX 1075, 959 Gana Court, Mississauga, Ontario, Canada L4T 4C2

TRIO-KENWOOD U.K. LIMITED

KENWOOD House, Dwight Road, Watford, Herts., WD1 8EB United Kingdom

KENWOOD ELECTRONICS BENELUX N.V.

Mechelsesteenweg 418 B-1930 Zaventem, Belgium

KENWOOD ELECTRONICS DEUTSCHLAND GMBH

Rembrücker-Str. 15, 6056 Heusenstamm, West Germany

TRIO-KENWOOD FRANCE S.A.

13 Boulevard Ney, 75018 Paris, France

KENWOOD LINEAR S.p.A.

20125, MILANO-VIA ARBE, 50, ITALY

KENWOOD ELECTRONICS AUSTRALIA PTY LTD. (INCORPORATED IN N.S.W.)

4E Woodcock Place, Lane Cove, N.S.W. 2066, Australia

KENWOOD & LEE ELECTRONICS, LTD.

Wang Kee Building, 4th Floor, 34-37, Connaught Road, Central, Hong Kong